

STADIA PORTFOLIO



Via Tizzano 46/2
40033 Casalecchio di Reno
Bologna - Italy
Partita I.V.A. 02568991208

MJW
structures

Tel. +39 051 576232
Fax. +39 051 576006
studio@majowiecki.com
www.mjwstructures.com

Cairo – New Stadium

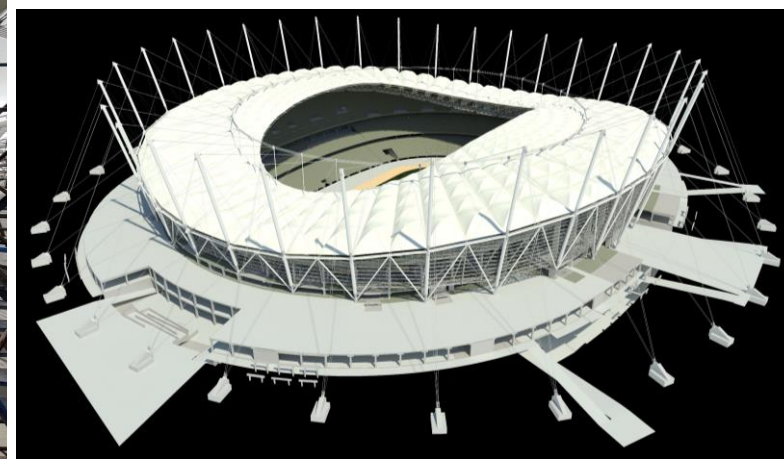
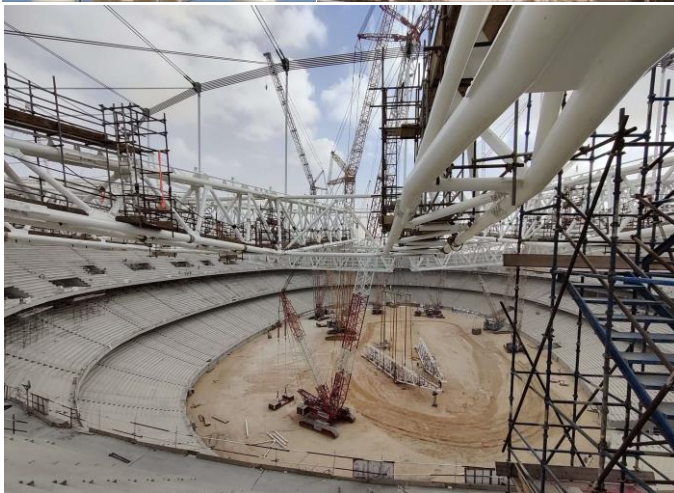

WORK DATA

Location	Il Cairo (EGY)
Year	2019 – 2022 in costruzione
Owner	Governo egiziano
Client	ORASCOM
Seats	93'000
Work budget	€ 270'000'000

STRUCTURAL DESIGN

Tender	X
Preliminary	X
Final	X
Building site support	X

DESIGNED ELEMENTS

Risers	Precast concrete structures
Grandstands	Cast in situ and precast concrete structures
Roof	Tensile structure
Roof Cover	Membrane
Foundation	Slab on ground and piles

Bologna – New Renato Dall’Ara Stadium

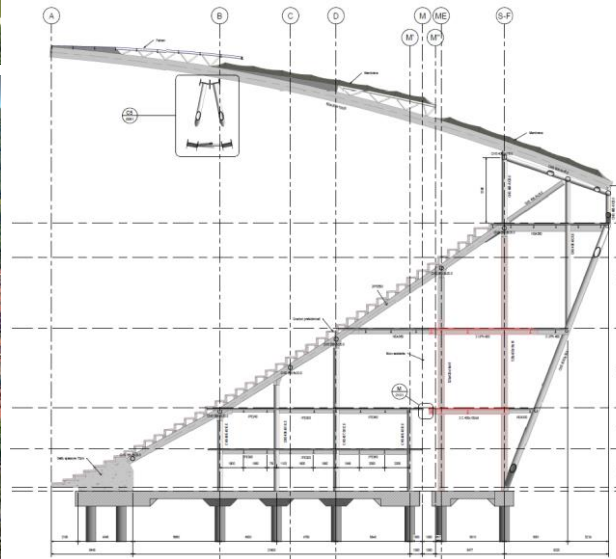
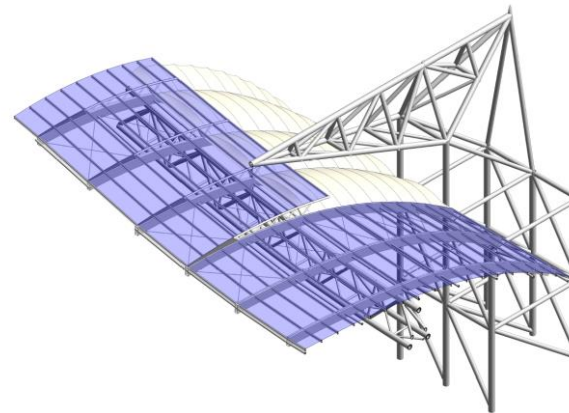
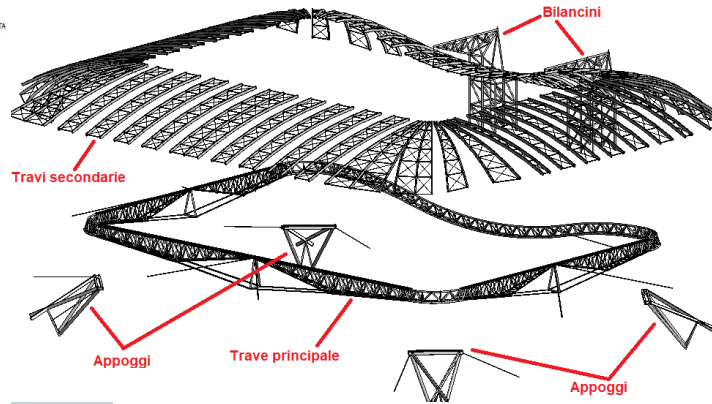
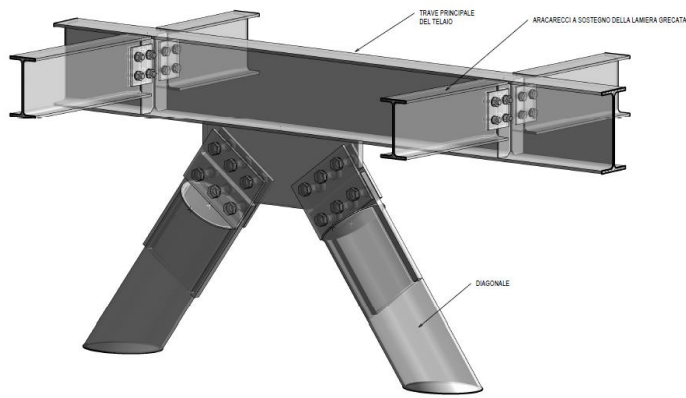

WORK DATA	
Location	Bologna (ITA)
Year	2017 – 2022
Owner	Bologna Football Club
Client	GauArena
Seats	30'000
Structural work budget	€ 63'000'000
STRUCTURAL DESIGN	
Tender	X
Preliminary	X
Final	In progress
Building site support	-
DESIGNED ELEMENTS	
Risers	Precast concrete structures
Grandstands	Cast in situ and steel structures
Roof	Structural system with main steel beams and secondary beams
Roof Cover	Membrane and palram
Foundation	Slab on ground and piles

Yaoundé – Paul Biya Stadium

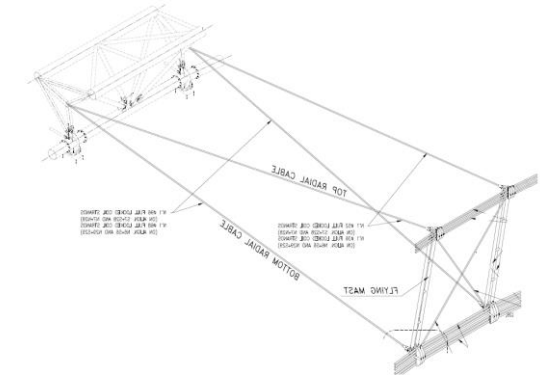

WORK DATA

Location	Yaoundé (CMR)
Year	2017 – 2022
Owner	Cameroon Government
Client	Piccini Group
Seats	60'000
Works budget	€ 92'500'000

STRUCTURAL DESIGN

Tender	X
Preliminary	X
Final	X
Building site support	X

DESIGNED ELEMENTS

Risers	Precast concrete structures
Grandstands	Cast in situ and steel structures
Roof	Spoke Wheel structure
Roof Cover	Membrane
Foundation	Slab on ground and piles

Athens – Agia Sophia Stadium

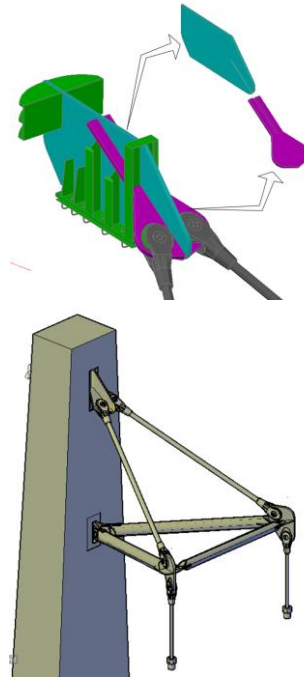
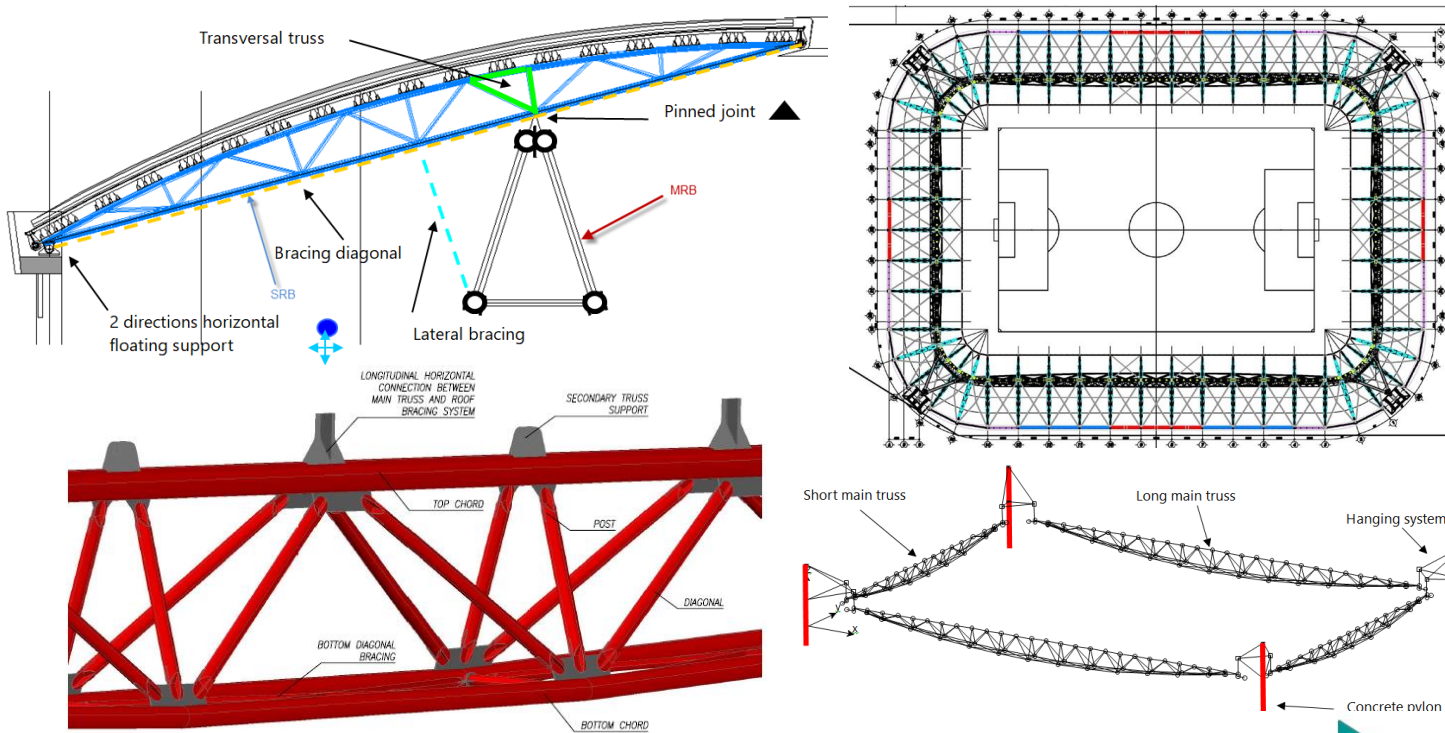

WORK DATA	
Location	Atens (GRC)
Year	2017 – 2021
Owner	AEK Atene Football Club
Client	AEK Atene Football Club
Seats	33'000
Works budget	€ 12'000'000
STRUCTURAL DESIGN	
Tender	X
Preliminary	X
Final	X
Building site support	-
DESIGNED ELEMENTS	
Roof	Structural system with hanged main steel beams and secondary beams
Roof Cover	Membrane

Iraq – As Samawah Stadium

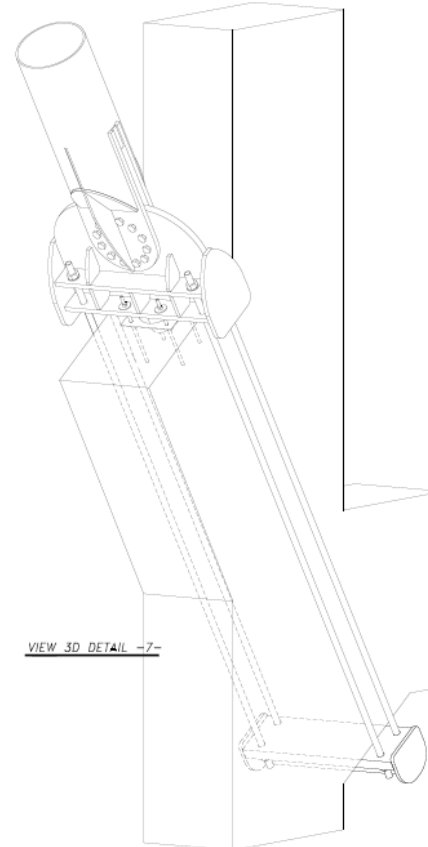
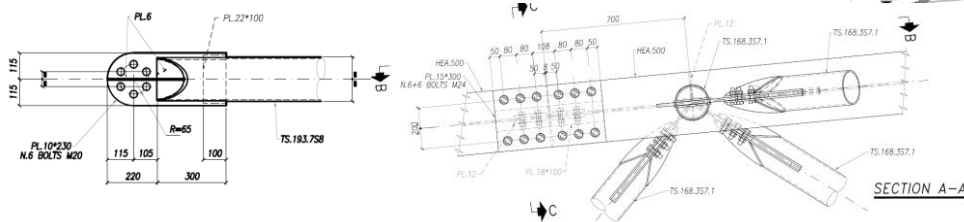
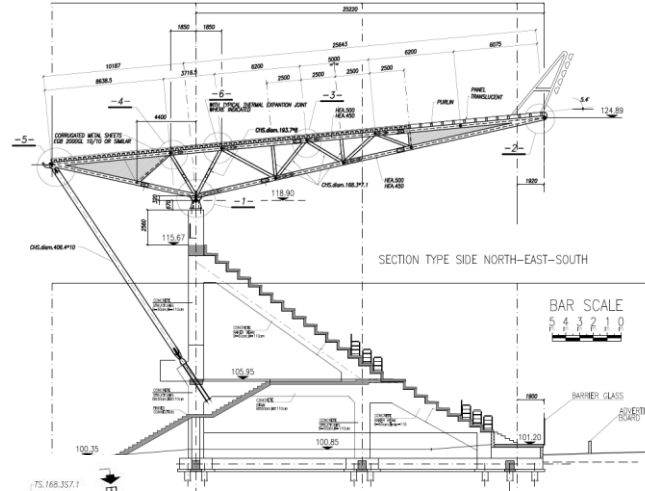

WORK DATA

Location	As Samawah (IRQ)
Year	2013 – 2015
Owner	Repubblica dell'Iraq
Client	T&T Costruzione S.r.l.
Seats	20'000
Works budget	€ 50'000'000

STRUCTURAL DESIGN

Tender	X
Preliminary	X
Final	X
Building site support	-

DESIGNED ELEMENTS

Risers	Precast concrete structures
Grandstands	Cast in situ and steel structures
Roof	Cantilever steel structure
Roof Cover	Membrane
Foundation	Piles

Turin – Allianz Stadium Juventus

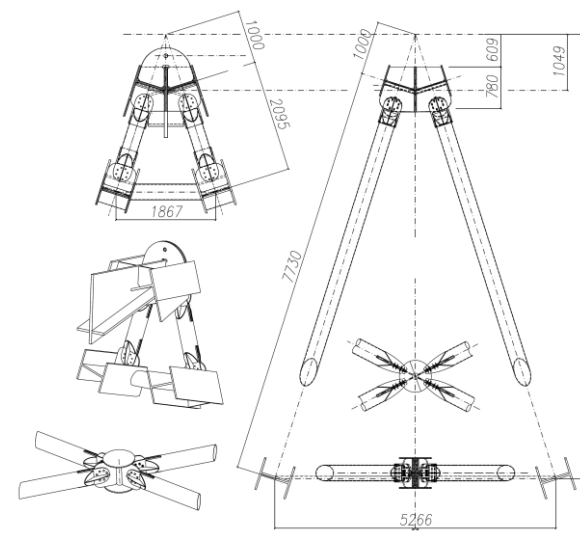
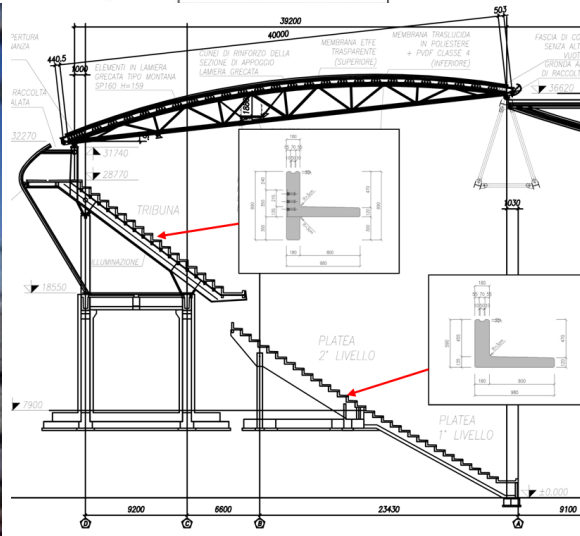
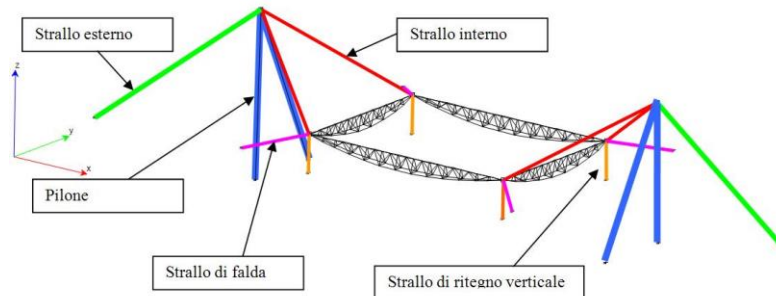

WORK DATA	
Location	Torino (ITA)
Year	2008 – 2010
Owner	Juventus F.C.
Client	Juventus F.C.
Seats	42'000
Works budget	€ 105'000'000
STRUCTURAL DESIGN	
Tender	X
Preliminary	X
Final	X
Building site support	X
DESIGNED ELEMENTS	
Risers	Precast concrete structures
Grandstands	Cast in situ and steel structures
Roof	Structural system with hanged main steel beams and secondary beams
Roof Cover	Membrane
Foundation	Slab on ground and piles

Larissa – AEL FC Arena

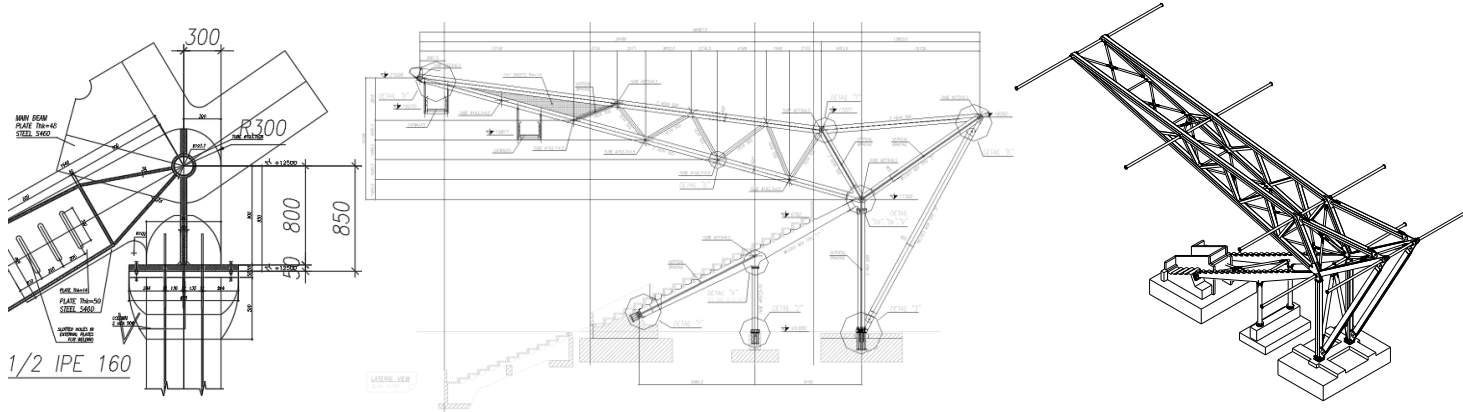

WORK DATA	
Location	Larissa (GRC)
Year	2009 – 2012
Owner	Larissa F.C.
Client	Larissa F.C.
Seats	16'000
Works budget	€ 41'000'000
STRUCTURAL DESIGN	
Tender	X
Preliminary	X
Final	X
Building site support	-
DESIGNED ELEMENTS	
Risers	Precast concrete structures
Grandstands	Steel structures
Roof	Cantilever steel structure
Roof Cover	Corrugated steel sheet
Foundation	Slab on ground

Athens – Panionios AC Stadium

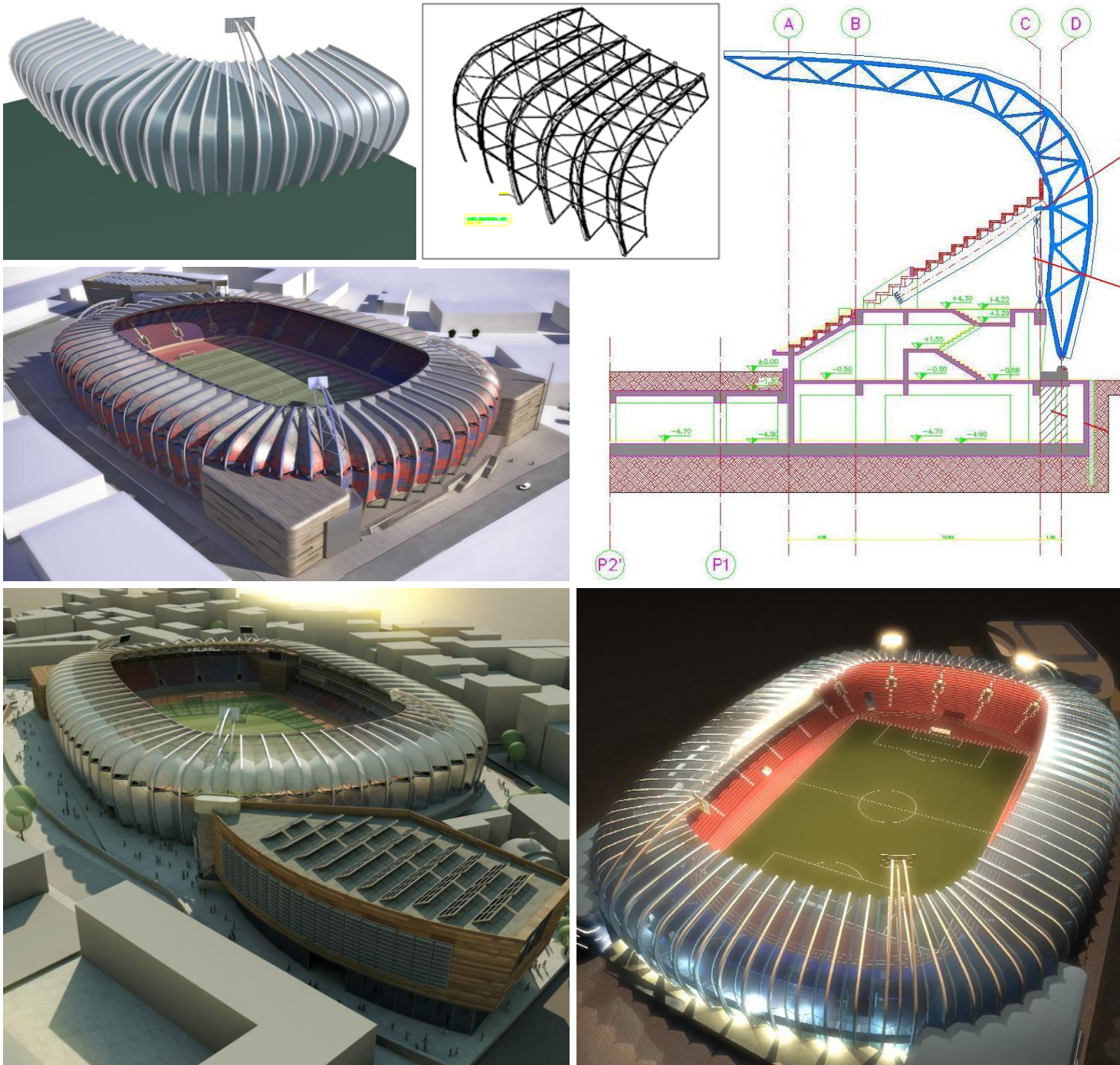

WORK DATA	
Location	Athens (GRC)
Year	2009
Owner	Panionios Gymnastikos Syllogos Smyrnis - P.G.S.S.
Client	Dimand S.A.
Seats	12'500
STRUCTURAL DESIGN	
Tender	X
Preliminary	-
Final	-
Building site support	-
DESIGNED ELEMENTS	
Risers	Precast concrete structures
Grandstands	Cast in situ and steel structures
Roof	Spatial steel truss with curved beams
Roof Cover	Membrane
Foundation	Slab on ground

Modena – Alberto Braglia Stadium

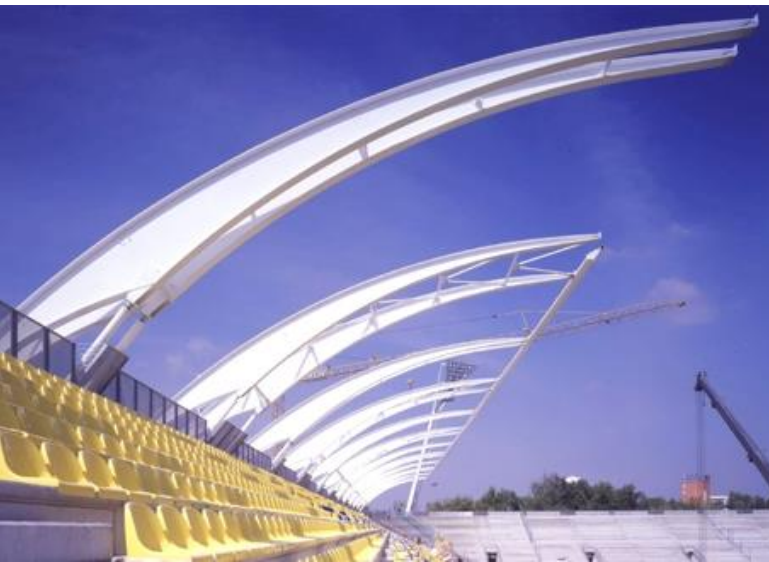

WORK DATA	
Location	Modena (ITA)
Year	2004 – 2006
Owner	Modena Municipality
Client	Modena Municipality
Seats	22'000
Works budget	€ 10'300'000
STRUCTURAL DESIGN	
Tender	X
Preliminary	X
Final	X
Building site support	-
DESIGNED ELEMENTS	
Risers	Precast concrete structures
Grandstands	Steel structures
Roof	Cantilever steel structure
Roof Cover	Membrane
Foundation	Slab on ground and piles

Braga – Council stadium Roof

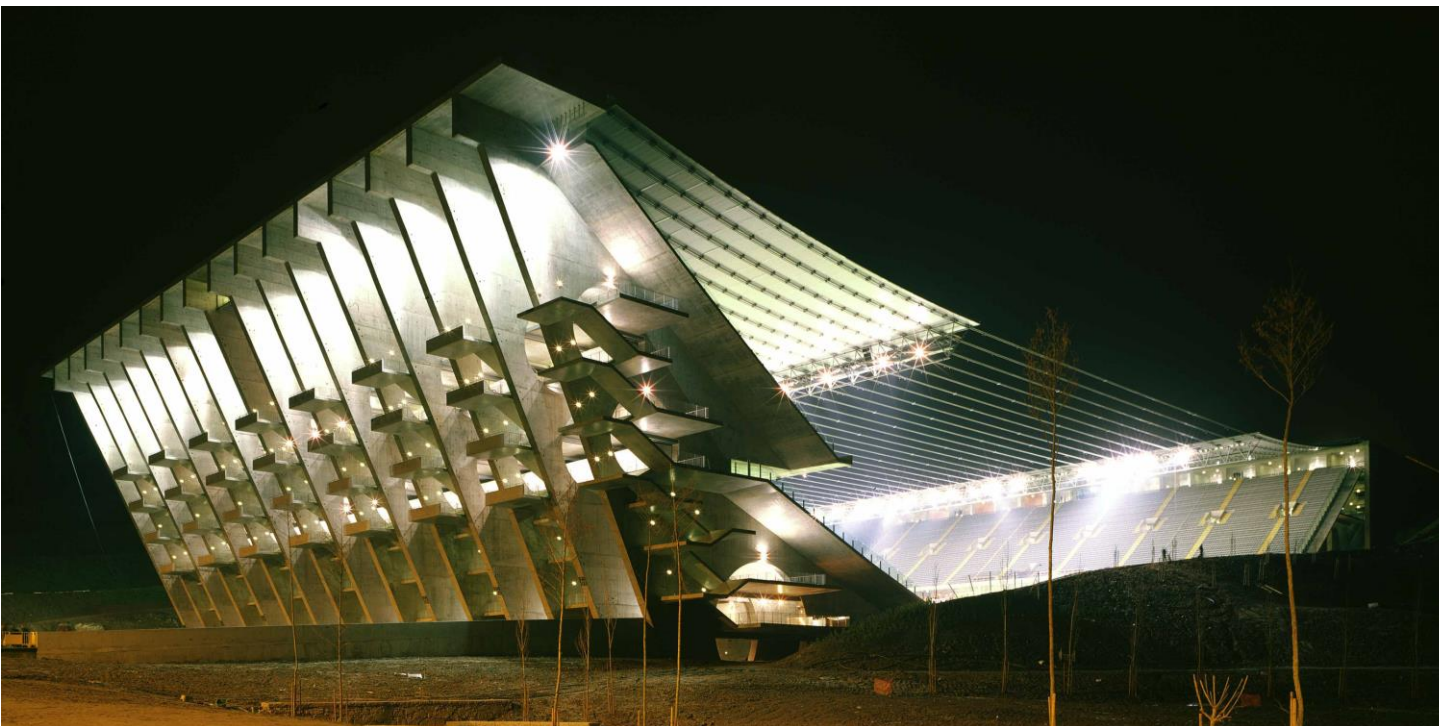
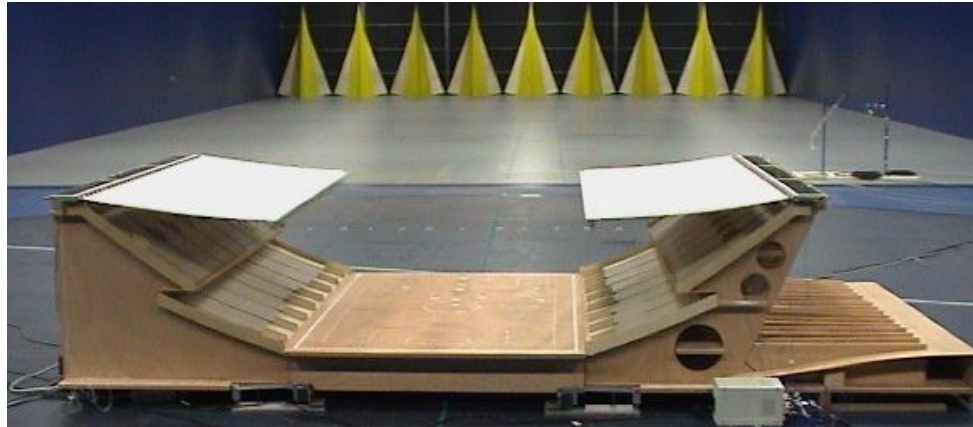

WORK DATA

Location	Braga (PRT)
Year	2003 – 2004
Owner	Braga Municipality
Client	Soc. Soares da Costa
Seats	30'500
Works budget	€ 120'000'000

STRUCTURAL DESIGN

Tender	-
Preliminary	-
Final	X
Building site support	-

DESIGNED ELEMENTS

Roof	Cables and concrete structures
Roof Cover	Concrete slab

Athens – Olympiako Stadium

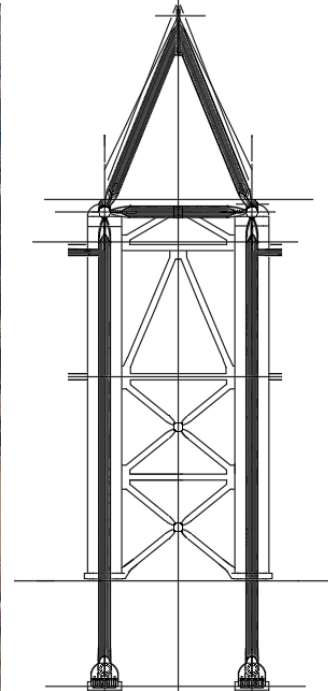
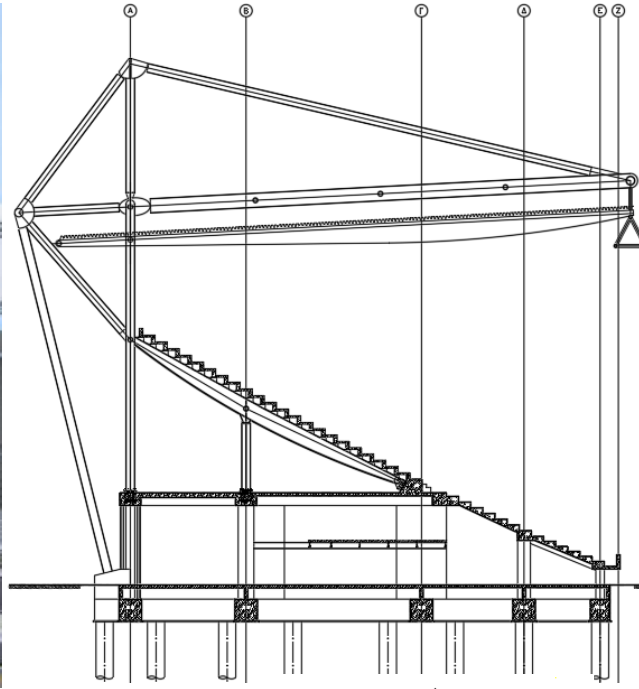
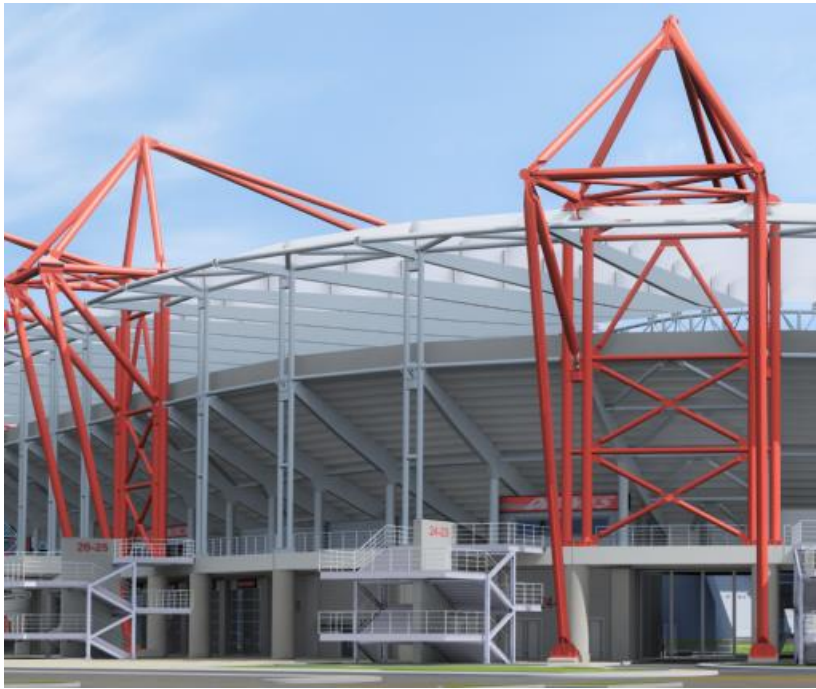

WORK DATA	
Location	Athens (GRC)
Year	2002 – 2004
Owner	Karaiskaki S.A.
Client	Karaiskaki S.A.
Seats	34'000
Works budget	€ 40'000'000
STRUCTURAL DESIGN	
Tender	-
Preliminary	-
Final	X
Building site support	-
DESIGNED ELEMENTS	
Risers	Precast concrete structures
Grandstands	Cast in situ and steel structures
Roof	Cantilever steel structure
Roof Cover	Membrane
Foundation	Slab on ground and piles

Venice – Marco Polo Venice

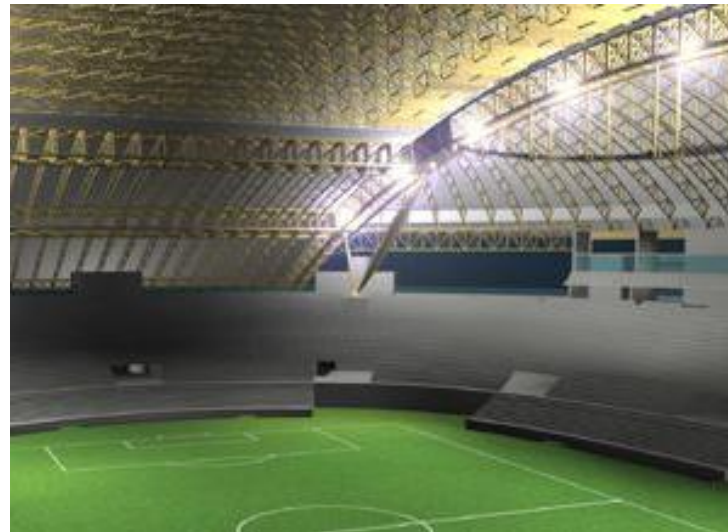
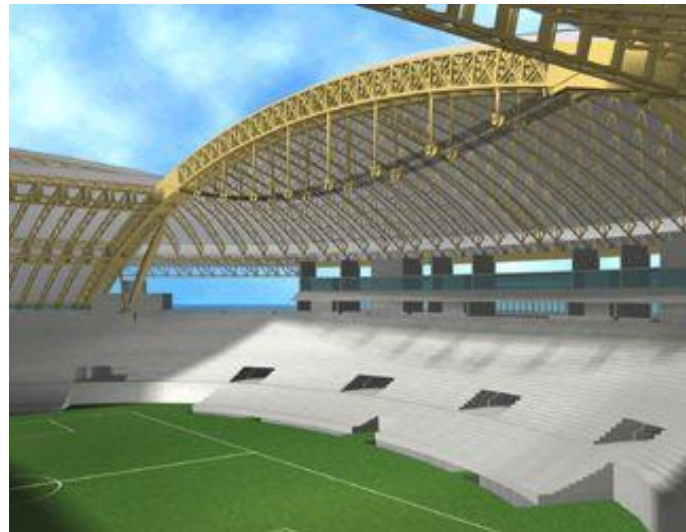
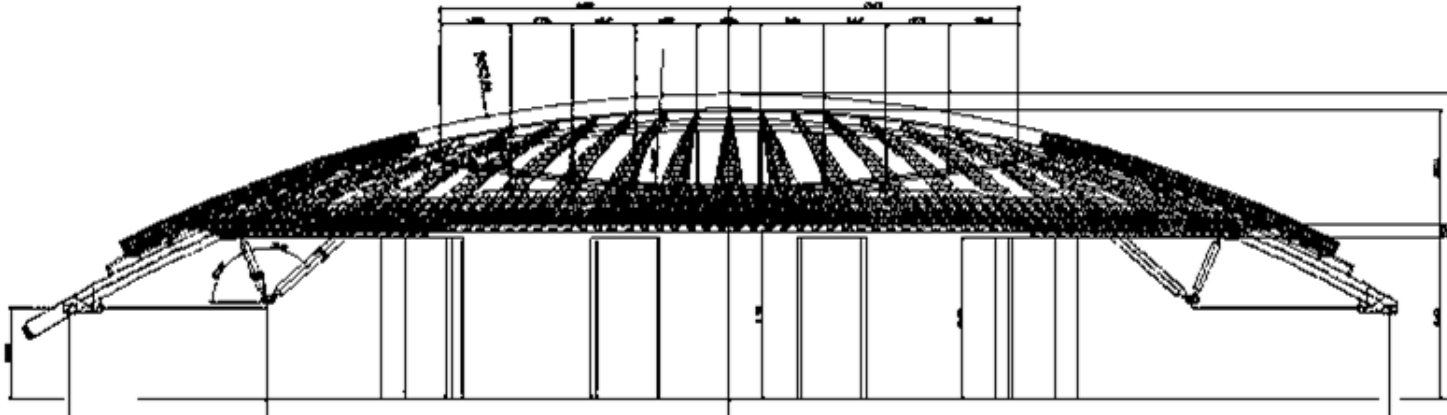
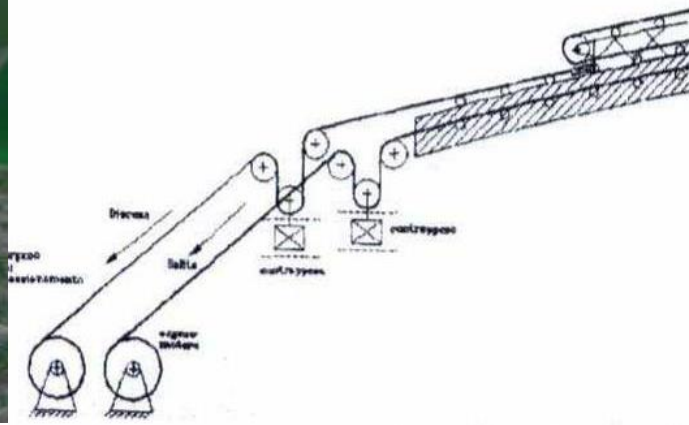
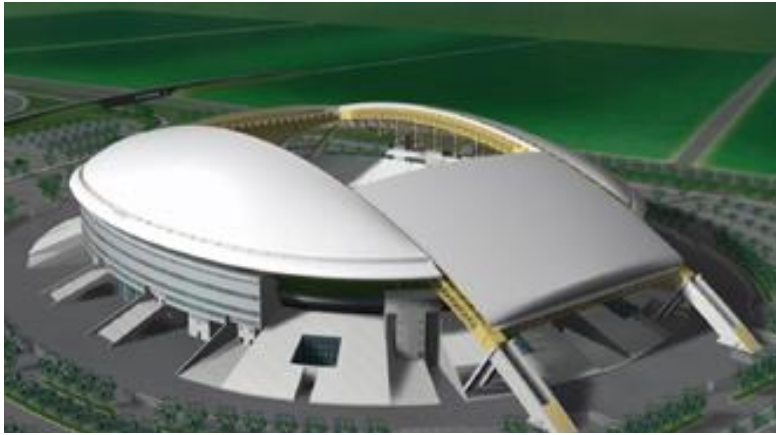

WORK DATA

Location	Venice (ITA)
Year	1999
Owner	Marco Polo S.r.l.
Client	Impresa Mazzi S.p.a.
Seats	30'000
Works budget	€ 62'000'000

STRUCTURAL DESIGN

Tender	X
Preliminary	X
Final	-
Building site support	-

DESIGNED ELEMENTS

Risers	Precast concrete structures
Grandstands	Cast in situ concrete structures
Roof	Spatial retractable steel truss structure
Roof Cover	Membrane
Foundation	Slab on ground and piles

Ohita – Stadium

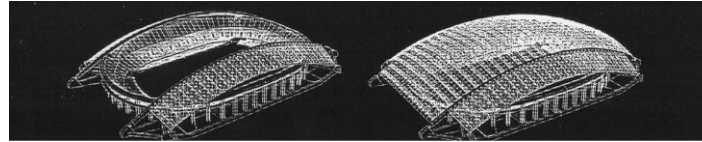
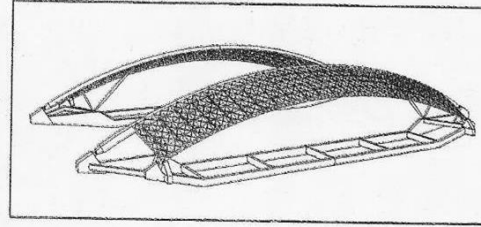

WORK DATA

Location	Ohita (JPN)
Year	1998
Owner	Kajima Corporation Ohita Giappone
Client	Kajima Corporation Ohita Giappone
Seats	35'000
Works budget	€ 120'000'000

STRUCTURAL DESIGN

Tender	X
Preliminary	-
Final	-
Building site support	-

DESIGNED ELEMENTS

Risers	Precast concrete structures
Grandstands	Cast in situ concrete structures
Roof	Spatial retractable steel truss structure
Roof Cover	Membrane

Turin – Delle Alpi Stadium

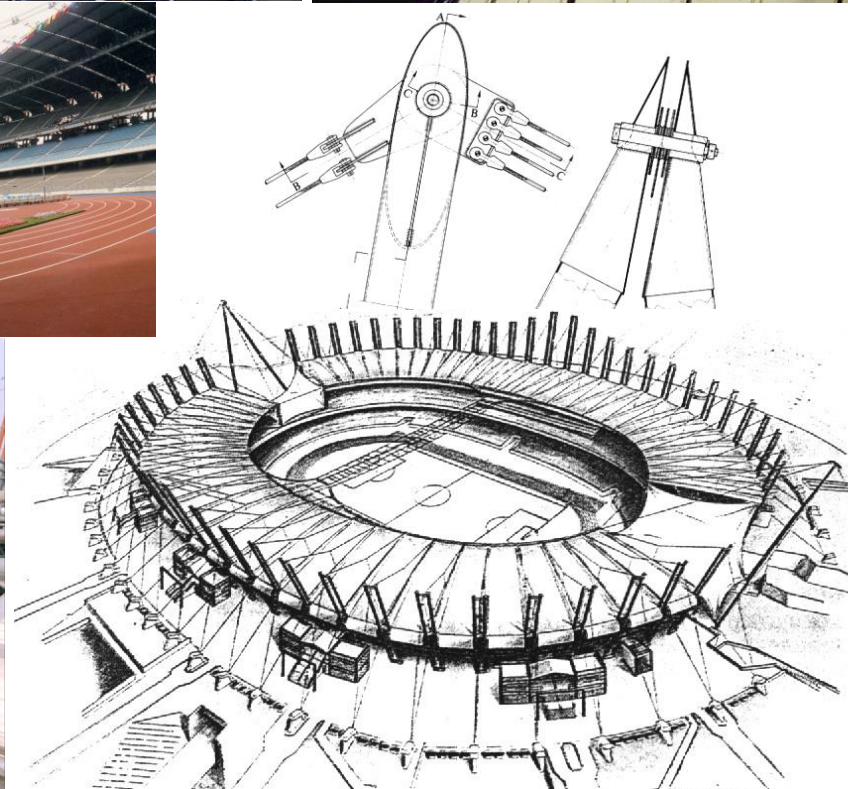
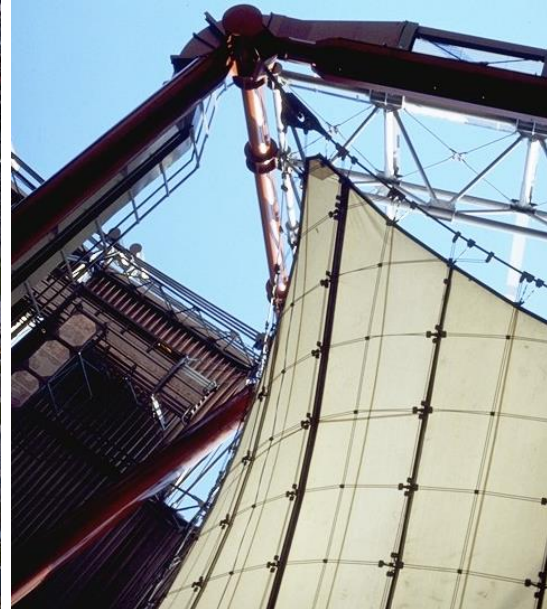

WORK DATA	
Location	Turin (ITA)
Year	1990
Owner	Comune di Torino e Juventus Football Club S.p.A.
Client	Acqua Marcia S.p.a.
Seats	70'000
Works budget	€ 65'000'000
STRUCTURAL DESIGN	
Tender	-
Preliminary	-
Final	X
Building site support	-
DESIGNED ELEMENTS	
Roof	Tensile structure
Roof Cover	Membrane

Rome – Olympic Stadium Roof

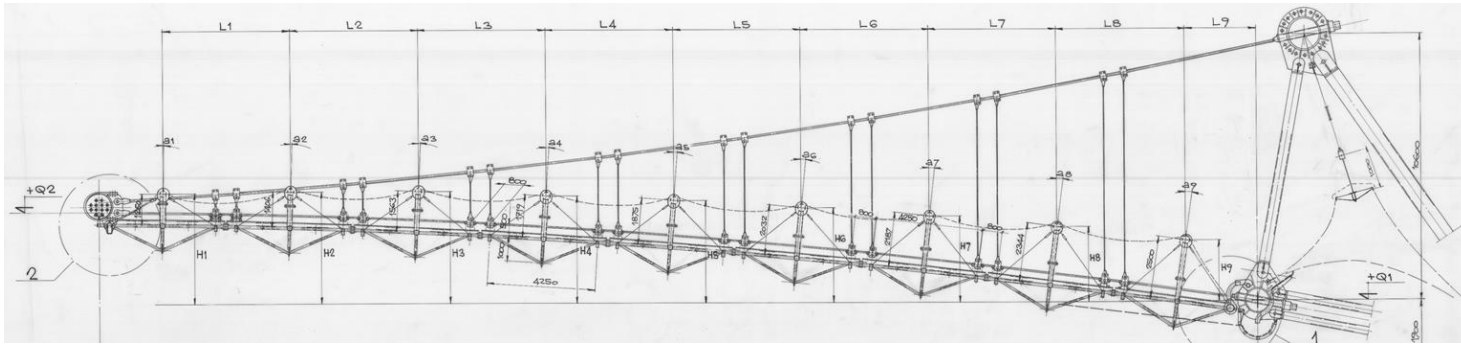

WORK DATA

Location	Rome (ITA)
Year	1990
Owner	CONI - Roma
Client	CONI - Roma
Seats	70'500
Works budget	€ 80'000'000

STRUCTURAL DESIGN

Tender	-
Preliminary	-
Final	X
Building site support	-

DESIGNED ELEMENTS

Roof	Tensile structure
Roof Cover	Membrane